

ABBERFIELD TECHNOLOGY

**Self Serve &
Cashier
Operated
Pay On Foot
Car Park
System**

**OPERATIONS
MANUAL**
Incorporating
separate
Application
Specific & As
Built details,
Maintenance
Manual,
Workshop
Manual

June 2006



32 Cross Street, Brookvale, Sydney, Australia
Tel: 61 (0)2 99392844 Fax: 61 (0)2 99383462



CONTENTS

Operations Section Page

System Description

INTRODUCTION	5
Pay on Foot Fee Collection System	6
SYSTEM OPERATION DETAILS	7
Drive Through Time	7
Exit Grace Time	7
Recycled Tickets	7
Ticket Types	7
Pass Card	8
Discount Card	8
Lost Card	8
Management Information	8

Equipment Options

EQUIPMENT OPTIONS	9
Ticket Loading Clearance	9
Module Replacement	9
Communications Module	9
Car Park Full Sign	10
Alarm Conditions	10
Desktop Controller & Manual Pay Station	11
Entry Stands	12
Self Serve Pay Station	13
Pay Booth	15
Parking Tickets & Pass Cards	16

Contents continued ...

Operations Section Page

Operations

ENTRANCE & EXIT OPERATIONS	17
OPERATING PARAMETERS	19
Clock Setting	19
Pass Cards	19
Drive Through	19
Site Code	19
Personal Identification Number (PIN)	19
Audit	20
Ticket Hold	20
Gate Acknowledgement	20
Auto Gate Open	20

Technical Section Page

COMMISSIONING	21
Introduction	21
Safety Note	21
Security Note	21
1.0 ENTRY & EXIT STAND INTRODUCTION	22
1.1 PLATFORM	23
1.2 WIRING DIAGRAM	24
Standard Equipment	24
Terminal Labelling	25
1.3 POWER SUPPLY / CONTROLLER SCDE	27

Contents continued ...

1.4	TICKET DISPENSER / ENCODER	30
1.5	SOFTWARE	31
1.6	ALARM CONDITIONS	32
	Relay Alarm	32
	Communications Alarm	32
1.7	INTERCOM	33
1.8	DRIVEWAY STAND	36
1.9	SETTING OF ENTRY & EXIT CONTROLLER	37
	Keyboard & Display Functionality	37
	System TEST (Status)	38
	Last Card	39
	Diagnostic	39
	Audit	40
	Personal Identification Number (PIN)	42
2.0	MANUAL PAY STATION DESKTOP CONTROLLER	46
	Cash Drawer	47
	Receipt Printer	47
	Customer Display	47
2.1	SETTING OF DESKTOP CONTROLLER	48
	Access	49
	Set-Up	49
	Setting Menu Access P.I.N.	51
	Changing User P.I.N.	52
	Changing Administration P.I.N.	53
	Setting the Clock	54
	Installing Log On Shift P.I.N.	54
	Removing Log On Shift P.I.N.	55

Contents continued ...

2.2	OPERATING DESKTOP CONTROLLER	56
	Logging On	56
	Logging Off	57
	Encoding Cards	57
	Open Boom Gate	59
	Manual Payment	60
	Refund	60
	Audit	61
	Detailed Audit	61
3.0	PAY STATION	63
3.1	CASH COLLECTION PROCEDURES	64
	Low Security Cash Collection Method	64
	High Security Cash Collection Method	65
3.2	RESETTING CLOCK	66
3.3	FAULT INDICATION	67
	Error Codes	67
	System Reset	69
	System Update	69
	Technical Support	69
4.0	SERVICE	70
	Cleaning Magnetic Heads	70
	Dust Removal	71
	Cleaning Parking Tickets	71
	Receipt Ticket Storage	72
4.1	MAINTENANCE & WORKSHOP SERVICE	73

INTRODUCTION

This operation manual covers the standard Abberfield Pay on Foot system, which includes all features available to customers. This general purpose manual should be supported by a customer specific appendix showing the variations for each application.

PAY ON FOOT CAR PARK FEE COLLECTION SYSTEM

Entry

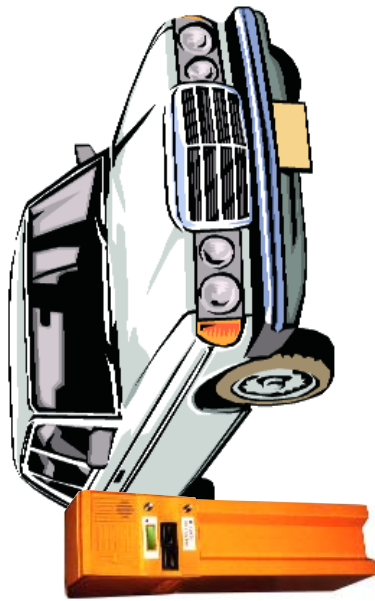

Pay Station

Self Serve or Manual

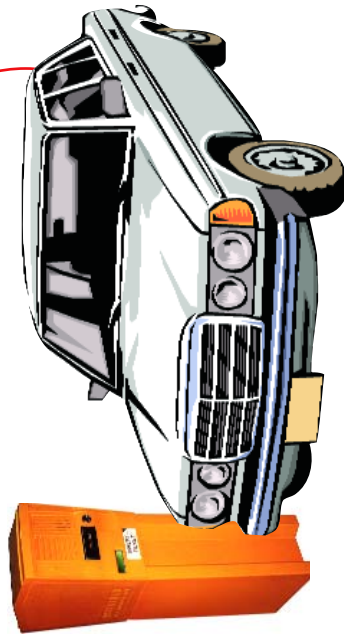

Exit

ENTRY

- * Card issued encoded with time and date details initiated by; Loop detector or push button or loop and button.
- * Boom gate opens.
- * Alarm output if fault occurs.

MANUAL PAYMENT

- * Card taken to cashier.
- * Inserted in desktop machine.
- * Screen shows fee due.
- * Pay notes and coins over counter.
- * Change given.
- * Receipt if required.
- * Card returned to driver.

OR

SELF SERVE PAYMENT

- * Insert card into Self Serve Pay Station
- * Screen shows fee due.
- * Pay notes and coins into machine.
- * Change given.
- * Receipt if required.
- * Card returned to driver.

EXIT

- * Insert card.
- * Card captured.
- * Boom gate opens.
- * Alarm output if fault occurs.

SYSTEM OPERATION DETAILS

Drive Through Time

It is possible to set an entry grace time to allow a car to drive out of the car park again, without parking and without paying, as may be necessary in a car park full situation. If the card from the entrance is taken straight to the exit it will operate the boom gate. This grace period is usually set for 10 minutes.

Exit Grace Time

It is normal to set a grace period of around 15 minutes between the time of payment is made and the time allowed to exit. This period can be set to any value. Should the driver exceed the period the ticket will be returned rather than captured and will need to be taken back to the cashier or Self Serve Pay Station again. Should a drive through period be set this adds to the exit grace time, ie. default conditions of 15 minutes exit time plus 10 minutes drive through time gives a total grace time of 25 minutes.

Recycled Tickets

Operated as detailed, the tickets can be recycled. If the tickets are plastic their life can be many times that of a paper ticket and then these tickets, although dearer to purchase, become the cheapest system, on a cost per transaction basis.

Ticket Types

A range of ticket types can be offered, such as Pass Card, Discount Card or Lost Card.

SYSTEM OPERATION DETAILS continued ...

Pass Card

These can be programmed for a preset number of entries, or a preset future date or both. If both are nominated the card is valid until the first occurrence of entry or date limit. The exit stand can be programmed to capture or return an expired pass card. If the Pass Card is inserted into the Pay Station the display will show remaining credit and the card will be returned to the driver.

Discount Card

Like a Pass Card, access is obtained to the car park but payment for parking must be made before using the exit. The Manual Desktop Controller or the Self Serve Pay Machines recognise the discount details and charges accordingly. When exiting, the card is returned and the boom gate does not open until the card is taken by the driver. This function can be set so as to only be active during certain times, such as "after hours".

Lost Card

If a driver loses his card an attendant can issue a "Lost" Card to allow exit. Some Self serve machines include a "Lost Button". Press this and the machine display shows a penalty fee. Pay the fee (notes, coins and change given) and a card is issued allowing exit.

Management Information

A printed audit ticket can be issued from the attendant's Desktop Controller at any time, plus when the attendant "logs" off. The Self Serve Pay Stations also issue an audit ticket. In addition, reporting may be provided on an office computer, of all car park activities, revenues collected, usage patterns etc. refer Management Information Manual.

EQUIPMENT OPTIONS

Ticket Loading and Clearance

The Entrance Stand can be loaded with tickets and the Exit Stand can be cleared of used tickets from a rear door without effecting normal use of either machine.

Module Replacement

The Entrance ticket dispensers and Exit ticket encoders slide into place and automatically plug into robust self aligning electrical sockets with gold plated contacts. This permits rapid on site replacement for service or maintenance purposes by unskilled operators. The display on the control module shows fault conditions to assist in service work.

This same principle applies to the components in the Self Serve Pay Stations and the cashiers Desktop Controller.

Communications Module

This device is optional and allows data transfer between a Desktop Controller and the Entrance and Exit Controllers. It is then possible to remotely close the car park, open boom gates, implement an active "anti Pass Back" feature, update clock settings in all units and maintain an active indication of cars in the car park, or conversely, spaces available.

EQUIPMENT OPTIONS continued ...

Car Park Full Sign

This can be provided in two ways. The normal is a sign driven from the Entrance Controller in conjunction with a Desktop Controller. In this way the sign is under automatic control based on the numbers of cars in the car park, or it can be directly controlled by the operator, from the Desktop Controller. Alternately a sign can operate under its own control, based on inputs from the Entrance and Exit boom gates.

Alarm Conditions

Entrance and Exit stands, Self Serve Pay Stations and Desktop Controllers include an alarm circuit to indicate a fault condition. This is usually wired for remote monitoring. If a communications module is included in the system, fault conditions can be transmitted by the data cables and then be displayed on the Desktop Controller.

Combined Pay Station / Exit

A Pay Station can be configured to act as a combined Pay Station and Exit. In this case payment is made from the car at the exit. This principle best suits those applications where an initial free period is provided, such as shopping centres. In this case, during the free period a ticket inserted will be captured and the boom gate will automatically open.

This combined Pay Station / Exit Station provides a particularly economic solution.

EQUIPMENT OPTIONS continued ...

Desktop Controller & Manual Pay Station



*Manual Pay Station
or Desktop Controller*

Stalk Display



Rear View



Manual Pay Station

Used to process parking tickets, control the car park or issue Pass Cards. All of these features can be achieved by simple keyboard entry. There is effectively no function that this compact device cannot provide and for all normal applications a host computer is not needed.

Desktop Controller

This is the same device as a Manual Pay Station, with a different programme. The name change reflects its use, usually at a reception or similar place, to issue Pass cards etc. Fitted with a communications module they can be used to remotely open boom gates and mirror some of the functions of a Manual Pay Station.

Equipment Options continued ...

Entry Stands

A common stand is used for the Entry and Exit configured by the modules installed and fascia fitted. Two types of base assemblies are offered. Stands are produced from aluminium and painted to suit the customer's requirements.

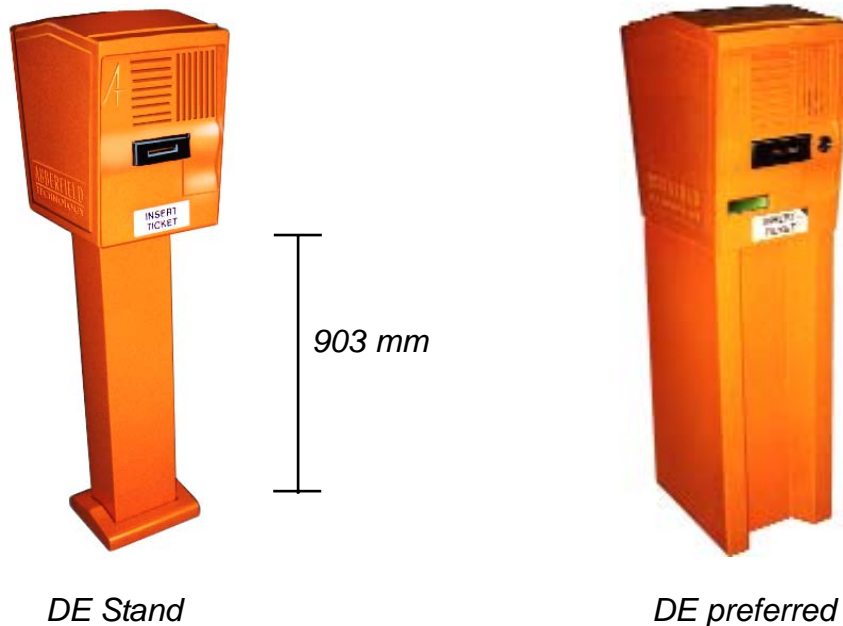

A standard height covers most applications, whether mounted on the roadway or an island. Stands to different heights can be produced to order.

Stands that "Goose neck" forward are also available.



Lower cost units can delete the intercom and display. The Entry "Press for ticket" button can be deleted if ticket issue is from a car park present loop only.

Equipment Options continued ...

Self Serve Pay Station

Several types of Pay Station can be offered to suit different applications and budgets. All Pay Stations are produced in stainless steel and painted to suit the customer's requirements.



APS 2500 Standard full featured machine

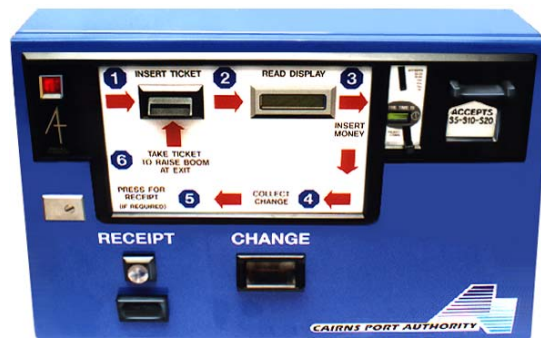

APS 2500P Premium grade full featured machine



APS 2500P with Lost Card and Prepay features added

Equipment Options continued ...



APS 2250 Full feature machine

The 2250 machine provides a compact housing yet complete functionality. It is the Pay Station best suited for combined Pay Station / Exit Station applications.

APS 2000 Compact full feature machine



NEW - EVEN SMALLER!

Equipment Options continued ...

Pay Booth



Pay Booth

For cash processing of parking tickets, available in various formats. The standard booth can have two self serve Pay Booths incorporated into the front wall. These can have different capabilities but the concept is to have one machine take all notes and coins, give change etc. and the other machine to take notes and coins without change giving. Housings are made from aluminium frame and stainless steel cladding. The roof can be plain or an optional curved roof can be added. The Booth can be bolted securely and permanently wired or it can be portable with electrical connections plugged in as needed.

Equipment Options continued ...

Parking Tickets & Pass Cards

The Abberfield system will operate on paper or plastic tickets and these are the same length and width as a credit card but usually thinner. It is strongly recommended that plastic is used as this allows the parking ticket to be recycled and although dearer to purchase than paper the plastic will provide the cheapest per use cost of any system.

Pass Cards are the same as the normal parking ticket but if preferred they can be of thicker material. Generally it is recommended they are 0.4mm thick, about half that of a credit card.

Cards can be obtained from Abberfield and produced in any quantity through the company's own bureau printer. Customer specific artwork is produced in house and cards personalised with a user photo can also be provided.

Wherever possible plastic cards of Polyester material should be used, as they provide excellent performance.

Lower cost P.V.C. material cards may also be used, but they may cling together and therefore require the ticket dispenser to be operated with a reduced stack height.

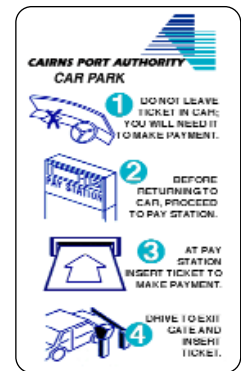

ENTRANCE & EXIT OPERATIONS

Ticket Operations

The concept is that tickets are reused, removed from the Exit machine and restocked into the Entrance. Whilst this can be done directly, it is recommended that the tickets are taken to an office type environment for inspection and cleaning, and only then taken to Entrance stand for re-use. This gives an opportunity to ensure that each magnetic stripe is intact and the ticket is not bent.

If tickets are transferred directly extra care should be taken not to drop them and they will collect dust and dirt which will subsequently be deposited on the card reading head.

In any event it is important to ensure that water does not collect on the tickets as this will cause them to cling together and prevent proper ticket dispensing.

Whilst the proper care of tickets does take a little time, it is a simple matter that can be done during a quieter time. Recycling plastic tickets remains the most cost effective system.

Machine Operations

The Entrance and Exit Stands use a common software programme. When first powered up the software interrogates the hardware attached to the network bus. If a ticket dispenser is present the system operates on the car park Entrance software. Without a ticket dispenser it assumes the system is to operate on the Exit software.

Configured in this way the intelligent power supply in an Entrance or Exit Stand is the same, simplifying spare parts requirements.

Each power supply has a key pad and a display, allowing setting of the operating parameters. These can be protected by a Personal Identification Number (P.I.N.) which can be installed at time of commissioning. This P.I.N. can be changed at any time, having first entered the existing P.I.N.

If no P.I.N. number is present access is gained directly to the parameters file.

Entrance & Exit Operations continued ...

A second "Administration" P.I.N. is used to gain access to higher levels of control or parameter adjustment and a third "Factory" PIN allows total access to all parameters.

Should ever the P.I.N. be forgotten and need changing, refer to Abberfield Technology for engineering support.

The following information is an outline of some service menu messages and setting options possible with the Entrance or Exit power supplies. The branching nature of the software becomes particularly complex but the screen prompts make understanding the procedure relatively self evident. Further information is provided in the appendix or in the Driveway Entrance and Driveway Exit Workshop Manuals.

The following information will act as a guide to system operators.

OPERATING PARAMETERS

Clock Setting

The clock must be set carefully so that the clocks in each of the Entrance Stands, Desktop Controller, Self Serve Pay Station and Exit Stands all agree. If the communications module is included, setting the Desktop Controller automatically sets the Entrance and Exit via the network. Setting of the Pay Station is automatic via the cash box processing procedure, obtaining its time from the processing computer. However the setting can be manually achieved at the Pay Station.

Pass Cards

These can be captured or returned by the Exit Stand on their last valid use.

Drive Through

The period can be set from 0 to 99 minutes.

Site Code

A code can be entered into the Entrance and Exit machines to ensure that parking cards from one site will not operate another car park.

Personal Identification Number (P.I.N.)

If no P.I.N. is entered the parameters menus can be accessed by pressing "enter". There are three P.I.N.'s, one a menu P.I.N., the next an "Administration" P.I.N. and the third a "Factory" settings P.I.N. for critical settings. It is recommended that once the parameters are established a P.I.N. is used. This will ensure accidental changing of parameters does not occur. If the parameters are changed it may appear that the system is faulty and considerable time is then wasted in diagnosing the problem.

Audit

An audit of the number of tickets dispensed from the Entrance or received by the Exit is available, by reading the display on the Entrance and Exit Stands. The audit totals cover each month and also includes an overall total count.

This audit information is separate from any information gathered on the Management Information System (if fitted), or the information from the Desktop Controller.

Ticket Hold

The Entrance and Exit controllers can set the position of the ticket as it is issued, or if a Pass Card, as it is returned to the driver. This is used to ensure that when dispensed the ticket is just held in the front pinch roller. In this position it will not be blown out of the stand by strong wind.

Gate Acknowledgement

For each card issued at the Entrance and Exit Stands a pulse is generated to operate the boom gate. If the boom gate is already operated when the next card is inserted the pulse can be lost. This may happen if one vehicle is still leaving whilst the next is able to get in position and operate the card reader, or an attendant inserts the card to help the flow of traffic but does this too early. In this case the boom gate will close and lock the vehicle out, for an Entrance situation, or lock them in if the Exit were being used.

To prevent this occurring the boom gate should have a counter fitted and re-operate after each car. However some boom gates don't have counters. In these cases the "Gate Acknowledgement" feature of the Abberfield controllers can be used. This requires the boom gate to provide a pulse to the controller each time it operates. The controller in the Entrance or Exit Stands will not output the next pulse until the boom gate issues a pulse. In this way no locking in or out of vehicles is possible.

Auto Gate Open

This feature allows opening of the Entry or Exit boom gate at a preset time and then closing the gate again at another time.

The normal application is to open only the Exit gate during night time hours, closing it again before business hours in the morning.

COMMISSIONING

Introduction

This Commissioning Manual has been written for the operators of the Abberfield Technology magnetic card parking equipment. The aim is to allow customers to install and configure the equipment or reconfigure it as circumstances dictate.

Abberfield Technology welcome any useful information for the purpose of updating this manual.

Safety Note

Avoid spilling oil or water, or letting excessive rainfall into the machine whilst it is open. The cabinet is generally environment-proof and low voltage is used for personal safety. However, some components, such as the ticket dispenser module may be adversely effected.

Security Note

Abberfield Technology do not record key numbers used on the locking systems for each customer. Please ensure this number is safely but securely recorded.

Assumptions

It is assumed that the mains supply is reliable 240v and relatively free of line spikes. IF in doubt, fit line filters or uninterruptible power supplies. Training is available at Abberfield for owners, installers and operators.

1.0

ENTRY & EXIT STAND

INTRODUCTION

The driveway stand is the same design for both the Entrance and the Exit applications. Then the inner platform carrying the modules differs, although the wiring loom, connecting the outside cables to the modules on the platform is the same.

The power supply / controller and ticket dispenser / encoder modules plug directly into the platform of the entrance stand to provide easy service. Likewise the power supply / controller and ticket encoder plug directly into the Exit Stand platform.

model DETDE40

Equipment Comprises

- 1 x Power supply / controller.
- 1 x Card dispenser / encoder.
- Optional second card dispenser / encoder.
- 1 x Optional customer display.
- 1 x Optional intercom module.
- 1 x Optional communications module.

model DETE40

Equipment Comprises

- 1 x Power supply / controller.
- 1 x Card encoder.
- 1 x Optional customer display.
- 1 x Optional intercom module.
- 1 x Optional communications module.

1.1

PLATFORM

This comprises a base with module connecting plugs at the rear. These plugs transfer 12 volts supply and data communication between the modules.

Incoming power and control wiring plugs directly into the power supply / controller through a slot in the base of the platform.

As the dispenser / encoders for the entrance stands are twice the length of the encoders in the exit stands, the platforms for entrance and exits are different.

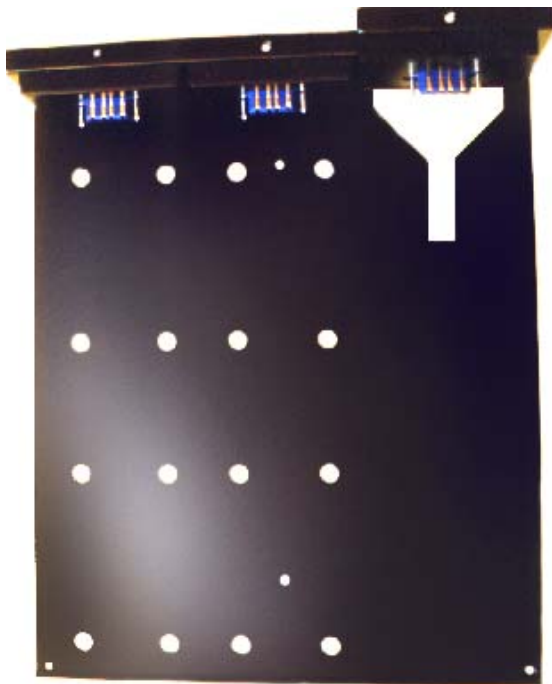

Driveway Entrance Platform

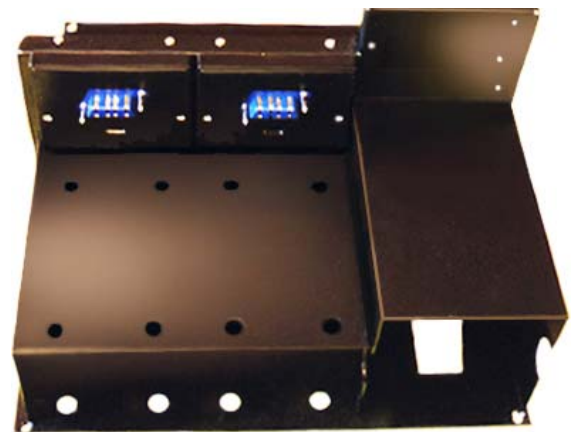

Driveway Exit Platform

1.2

WIRING DIAGRAM

Standard Equipment

Connections include: -

1. Incoming supply, normally 240 V A.C. but could be 12 V A.C. or D.C. and still be standard. Systems are available in other voltages, by special order.
2. Input from car detection loop. This is optional as the system can be made to issue a ticket by the driver pressing a button on the Entrance stand. It is normal to operate on a voltage free circuit but the controller can be set for low voltage input if required.
3. Relay contacts for the boom gate.
4. Alarm output wires to operate a remote indicator panel.

Note: Where the communications module is used the alarm signal can be sent via this link. In this case the alarm circuit can then be used for other functions, the most likely being to operate a Car Park Full light.

5. Optional communications connections.
6. Intercom connections.

All incoming wiring is terminated in a screw connected terminal block, and from there flexible wires make contact with the power supply / controller. There are three terminal blocks so as to isolate the intercom and the communications cables from any A.C. supply wiring as this may induce some electrical interference. To further minimise hum from the intercom, if incoming cables are shielded, the shield can be connected to the driveway stand earth via the terminal block.

Section 1.2 continued ...

Terminal Labelling

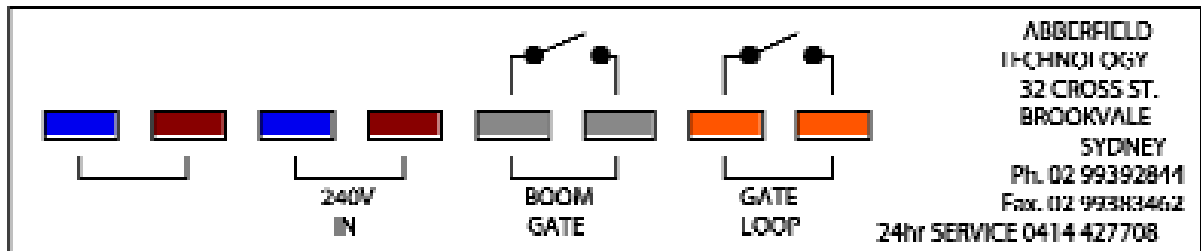

Electrical inputs

The orange gate loop wires on the entry stand are also connect to a small circuit board to the right front of the stand. On this circuit board is mounted a reed switch operated by a moving magnet on the “PRESS FOR TICKET” button. There are three positions for the orange wires;

- button only
- loop only
- button and loop

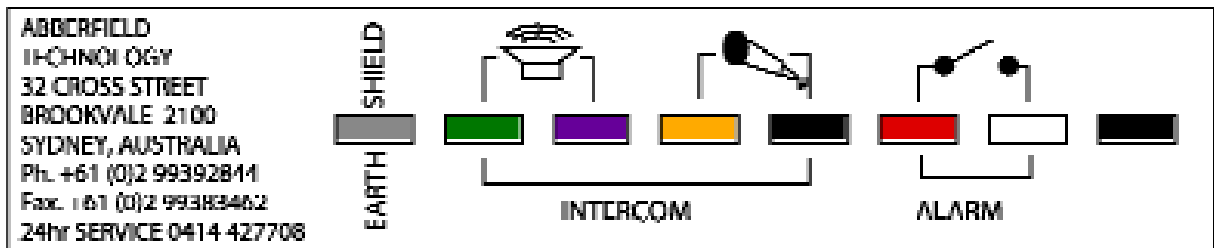





Intercom and electrical outputs

The intercom connections within the driveway stand are for the four wire Stentofon brand system. Terminal connections are marked with the microphone and speaker symbols and this arrangement should suit other four wire intercoms.

If a two wire system is used, the outside connections Green and Black are used. It is recommended that the black wire is connected to the negative wire of the intercom.

For three wire systems, ie. Aiphone LEF5 with two or more master stations, connect the green and black wires to the speaker circuit and the purple wire to the push button circuit. (Refer Manufacturers Manual).

Section 1.2 continued ...

ABERFIELD TECHNOLOGY 32 Cross Street, Brookvale 2100 Sydney, Australia Tel: +61 (0)2 99392844 Fax: +61 (0)2 99383462 24hr Service: 0414 427708	SHIELD	BLACK	RED	BLUE
				
	EARTH	COMMON	B-BUS	A-BUS

Communication Connections

Note: In existing systems only three wires are used, Common, B-BUS and A-BUS. This is a 485 communications protocol and when correctly connected a 5 volt signal will be shared across the terminals. Common to A-BUS will be higher than common to B-BUS, typically;

- A-BUS = 2.7 Volt
- B-BUS = 2.3 Volt
- Common = 0 Volt

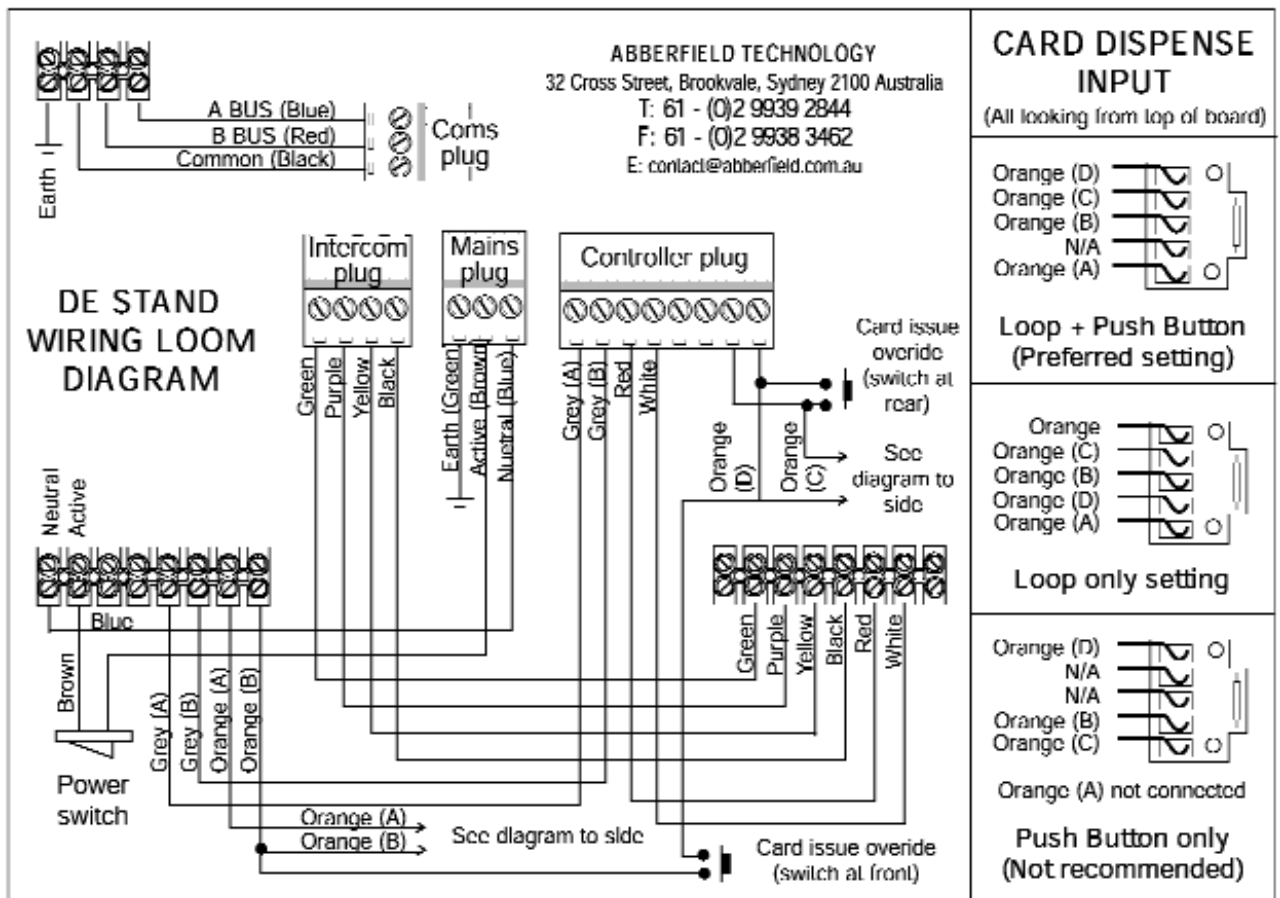

Pictorial of Wiring Harness of Driveway Stand Base Assembly

Note: Exit stand may delete card issue switches and card dispense input read switchboard.

1.3

POWER SUPPLY / CONTROLLER model SCDE

(As used in the Entry and Exit Stands)

This module combines both the low voltage power supply and the control electronics. It is a common unit with the driveway Entrance and Exit stands, although operating on different software. The power supply has parameters that can be set at time of installation so that it operates as an Entrance or Exit software. By carrying both programmes spare parts requirements are therefore simplified.

The data entry key pad and a display allows on site programming of operational parameters and diagnostic capability.



Front

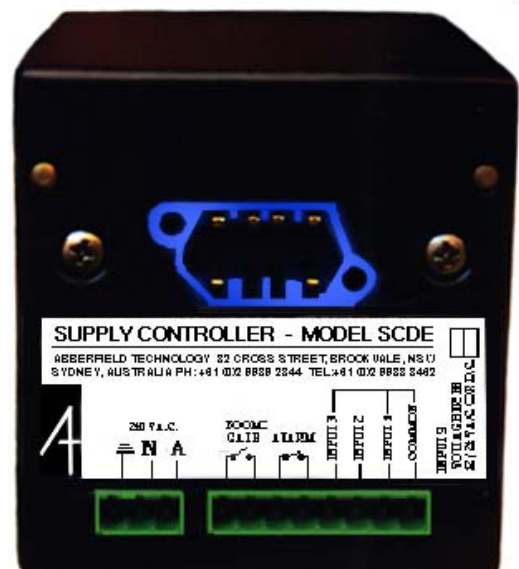

Back

Power supply / controller

Section 1.3 continued ...

Electronic connections are detailed on a label to the rear of the supply / controller.

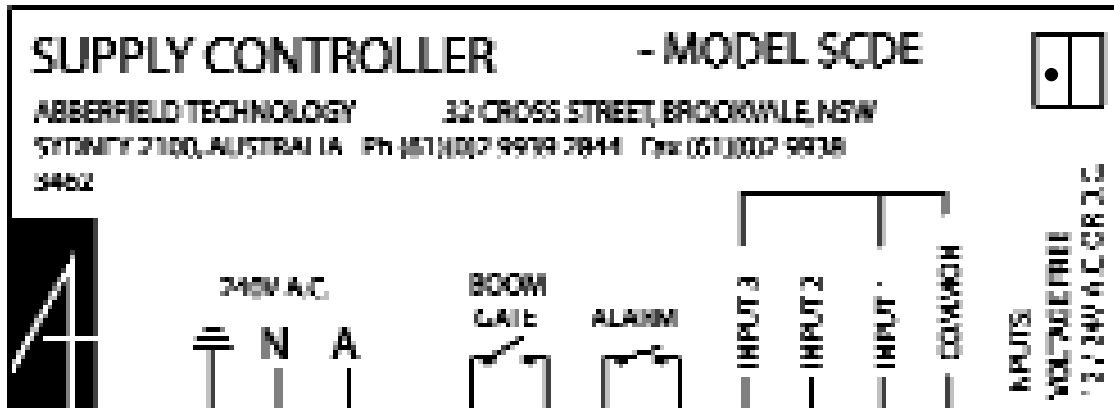

The hardware in the Entrance and Exit is the same, with the inputs to the supply controller operating differently in each situation.

Boom Gate Contacts

The contacts normally operate for two seconds as it has been found that some brands of boom gate require a pulse length of greater than 1.5 seconds.

Entrance

- Input 1 = Card dispense request.
- Input 2 = Car present enable loop.
- Input 3 = Gate open handshake.

Exit

- Input 1 = Gate open request.
- Input 2 = Car present enable loop.
- Input 3 = Gate open handshake.

The inputs can be either voltage free (external switch - no voltage applied) or 12 / 24 V A.C. or D.C. The settings are made internal to the supply / controller to change from one input type to the other.

For most (but not all) situations the voltage free input is used.

Section 1.3 continued ...

Also on the supply controller is a self aligning socket that engages with a plug mounted on the platform. The primary use of the plug is to provide 12 Volt supply and data connections to the rest of the Entrance or Exit system.

It is important that the two holding screws on the face of the power supply are secured to ensure that this plug and socket is engaged. Do not over tighten the screws. If the plug and socket do not connect properly the system will not operate at all. The message on the power supply will be uncertain and an amended software may be released soon to better support fault finding.

1.4

TICKET DISPENSER /

ENCODER

model TDTE40 (as used in the Entrance Stands)

This module combines two standard Abberfield products, the TD40 ticket dispenser and the TE40 magnetic card reader. They are joined by an interfacing plug arrangement that attaches to the ticket dispenser. Screws through the face of the magnetic card reader allow this module to be unplugged and used as a common spare part for the driveway Exit Stands or the Pay Stations.



Dispenser / Encoder

1.5

SOFTWARE

(Entrance and Exit Stands)

Although independent to the Manual Pay Station there is some common areas. The encoding of time and date is a common function throughout the system and the memory board hardware is the same as in the Entrance, Exit and Pay Stations.

The software in the Entrance and Exit carries both Entry and Exit programmes and can be set for either function through the parameter setting, at time of installation. In this way a spare power supply / controller serves for both the Entrance and Exit.

1.6

ALARM CONDITIONS

Alarms can be by a switched relay in the power supply controller, or if a communications package is included the alarm can come out in digital form. If alarmed by communications the normal alarm relay is usually used to operate other facilities, usually a Car Park Full Sign.

Relay Alarm

A relay in the power supply controller is held energised during normal operation. In case of a power failure or any other fault condition the relay will deactivate. This can then output to a remote alarm station.

The alarm list comprises any condition that has or ultimately will cause the system to partially or totally shut down.

Communications Alarm

Via the communication system, faults in each section of the Entrance and Exit stands is passed to a Desktop Controller. Using the Status key the operator can interrogate all parts of any system and learn of any difficulties.

1.7 INTERCOM

An intercom is optional and can be provided to operate in a number of ways. The intercom may be required to connect to an existing system in which case the hardware may need to be tailored to that system. All of these hardware configurations should fit into the standard Abberfield housings designed to be a plug in module within the housing.

Intercom



Stentofon Brand Intercom

Wiring of a 4 wire Stentofon Board (fitted to Abberfield housings)

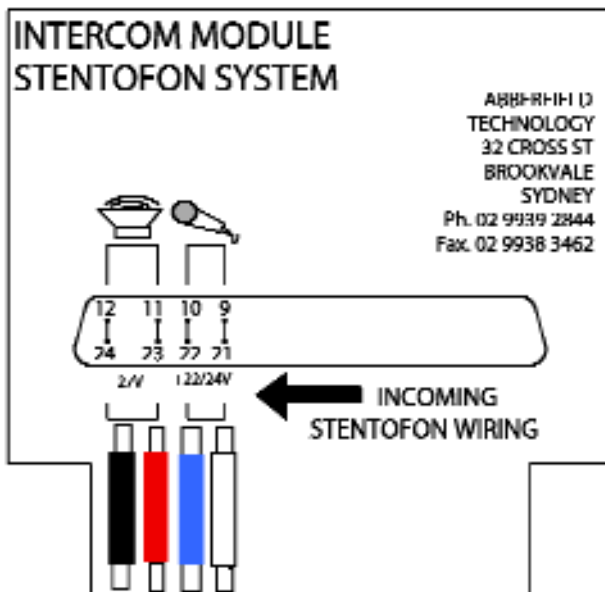

Wiring within the intercom housing showing the colours used by Stentofon - as they connect to the Abberfield self aligning plug and socket.

Section 1.7 continued ...

Aiphone Brand Intercom

1. Standard two wire system (fitted to Abberfield housings).
2. Modified two wire Aiphone system using amplified signals and 12Volts from the Entry or Exit Stands. Modified intercoms are best suited for long distances or noisy environments.

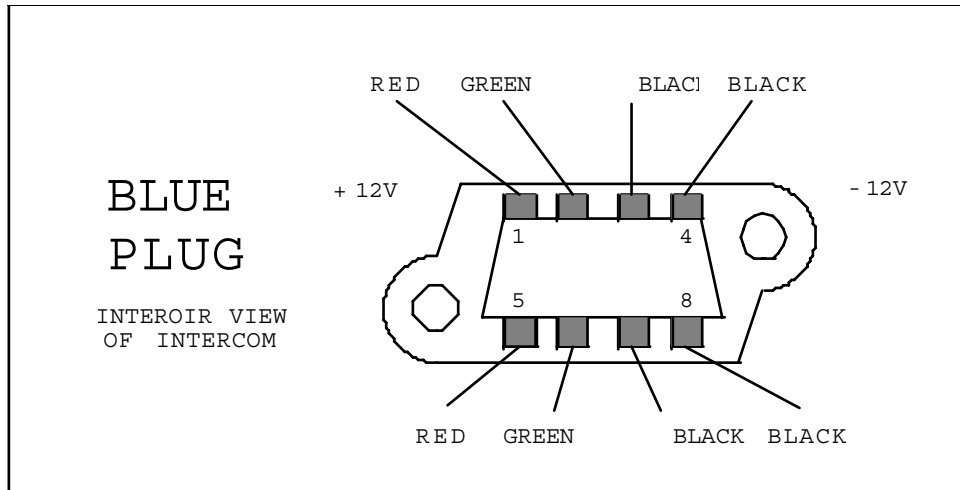

The center Black wire is the negative voltage and the Green wire is the other terminal. The outside Red and Black wires supply 12V D.C.. Standard and modified intercoms are interchangeable.

Analog intercoms are prone to "hum", generated by interference pick up from the A.C. mains supply. Therefore, the intercom cables should not run in close proximity to the mains cable. They should also be run independent of any other cables and should have an outer earth shielding. For best results cables should be a twisted pair so noise generation in one cable is cancelled by the other.

The longer the cable run the more chance of hum generation and therefore the separation of cables becomes more important.

Abberfield Amplified / Balanced Intercom

This is a modification of the Analog system, to allow operation over longer distances. A 12Volt supply is needed for each site (always available in the Entry and Exit Stands). The signal level transmitted is increased considerably, so as to negate the effects of electrical interference.

Analog Intercom Wiring

Communication Distance Calculation Graph

The following graph is to assist in determining the diameter of wires necessary for any given distance.

Example: To obtain the recommended distance for most intercom systems using 1.0mm diameter wires draw a line from the point on the left hand side (labelled Intercom Base Station) crossing the line 'B' at the point 1.0 to reach a point reading approximately 300 meters.

Wiring used for analog systems must not be run together with 240V cables as a "hum" will be induced on the signal. Where this cannot be avoided, or to obtain the best performance, an outer earth shielding on the intercom wires is recommended.

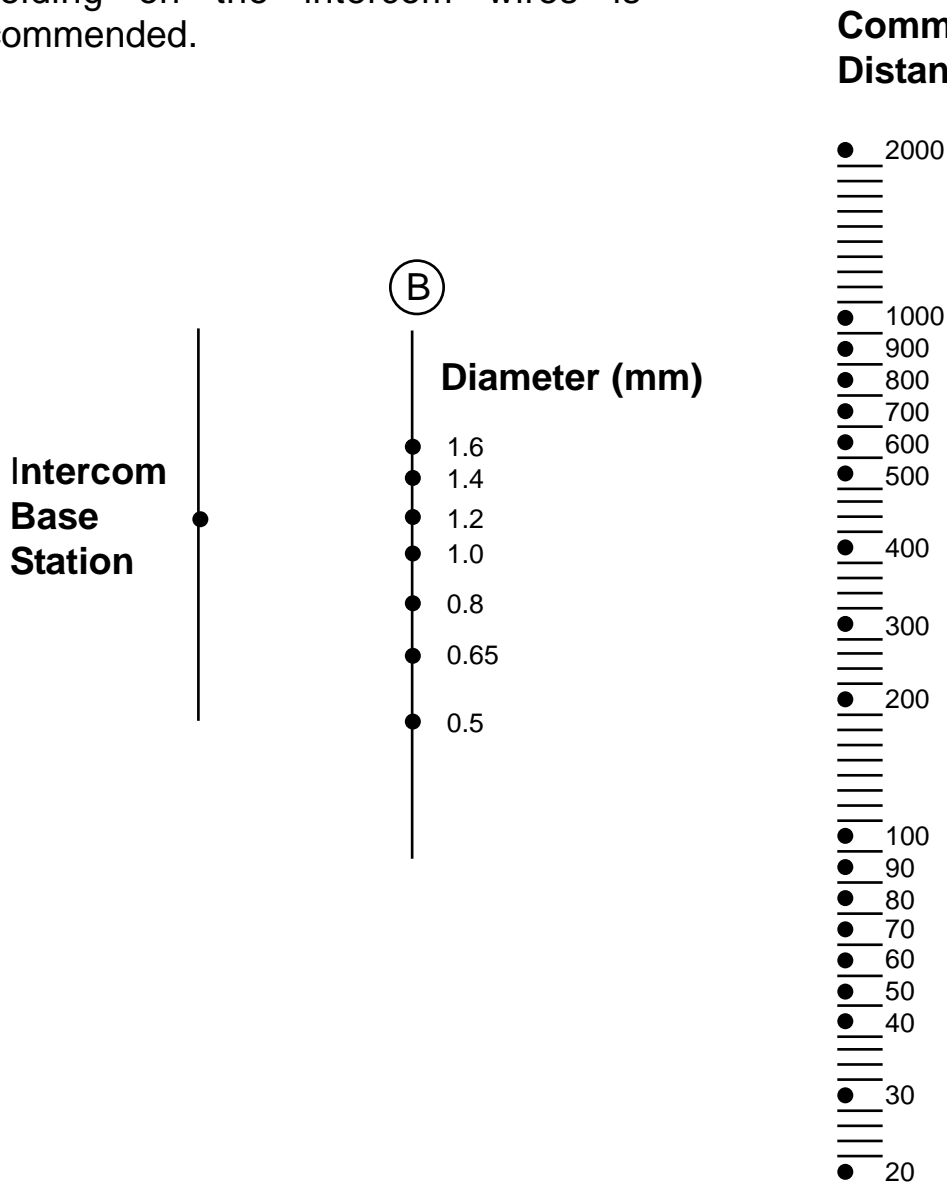

1.8

DRIVEWAY STAND

This comprises a fabricated aluminium base to which is bolted a cast hood. Cabling travels up the column and terminates in a screw connection block in the bottom of the hood. From there a flexible wiring harness connects to the power supply / controller.

Access to the hood is obtained by slip off lids to the front and rear of the stand. The locking system is concealed under the front and rear leading edges. In this position the locks are out of the public's view. Having rotated the lock the lid then pulls forward at the bottom and then slips down.

The loading of tickets can be accomplished from the rear so that this can be carried out whilst the equipment remains in use.

1.9

SETTING OF ENTRY & EXIT CONTROLLER

The power supply / controllers carry both Entrance and Exit programmes.

There are default parameters so that ex-factory the average operating requirements will be satisfied.

Keyboard & Display Functionality

The programme is structured so that it can step up a "Menu" by progressive selection of the number buttons. Stepping back down that menu is achieved by repeated pressings of the CANCEL button or by a time out repeated for each menu item. Use of the keyboard becomes easy once the operator is familiar with the messages on the screen.

Use of the keyboard is freely available to show the first menu item accessed by pressing ENTER.

The screen shows

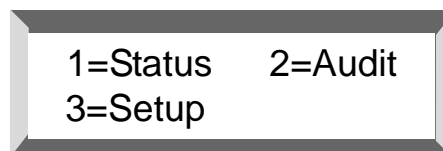

The free access menu continues for **Audit** and **Status** but **Setup** and all further menus are only accessed by a PIN.

Section 1.9 continued ...

System TEST (Status)

Press any key.

Screen displays

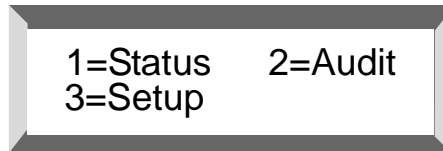

Press 1

Screen displays



Press 1

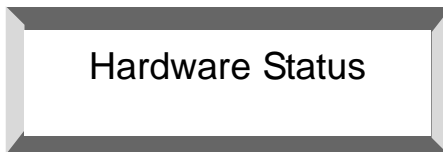

Followed by a scrolling message of each device, ie.

Mag 1 = Ready (no install)	}	This indicates the optional second dispenser / encoder as not been installed.
Tick 1 = Ready (no install)		
Mag 2 = no install (or Ready)		
Tick 2 = no install (or Ready) (or No Tickets)		
Coms = no - install (or Ready)		

If the magnetic card reader is performing normally the message will be "Ready". If it operates but has difficulty, the Ready sign will be followed by a ? number of retries. This gives a guide to the need for more regular head cleaning or other problem.

Note: When viewing the status of the machine, or operating particularly the entry machine, ensure that excessive sunlight does not flood the working parts. Entry and exits operate with the cover in place and sunlight can cause false errors.

Section 1.9 continued ...

Press CANCEL to exit or wait 30 seconds and the screen steps back down the menu to the previous message, ie.

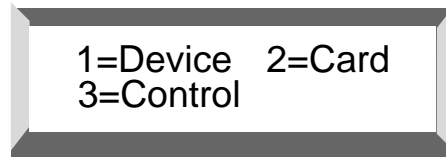

Last Card

In the Status menu pressing 2 = Card will then bring up the details of the Last Card used.

Press 2

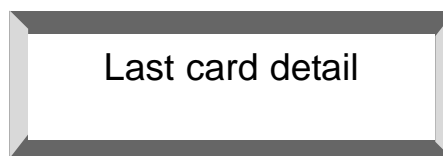

Then the screen scrolls to show:

Site code	?? =Identification where card can be used
Type code	? = type of card
Start	? = not valid before start date
Expire	? = not valid after expiry date
Value	? = Number of entries remaining
Used	? = Date last used
Used at	? =
Issue	? = Date issued
Sequence	? = Sequence number

Press CANCEL to exit



Diagnostic

Not used by operators but useful for Service technicians. In the Status menu pressing 3 = Control then the display scrolls the status of the controllers input and output connections.

Press 3

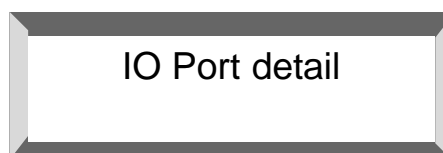

Section 1.9 continued ...

The screen scrolls to show the status of the input and outputs (IO) of the controller,

- ie. Input 1 = on or off
- Input 2 = on or off
- Input 3 = on or off
- Output 1 = on or off
- Output 2 = on or off

This is diagnostic text useful for fault finding.

Audit

The Audit gives a display of transactions **Today** (progressive through the day), **Yesterday** (midnight to midnight) and **Month** (current month to date and previous months). The **Month** is a twelve month data file so past data is backed up for one year.

Press the number keys to select the required item and follow the prompts.

Press ENTER for the first menu screen

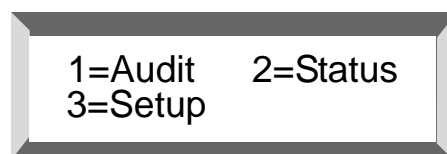

Press 1

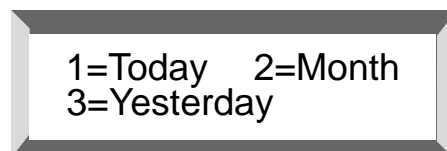

Press 1

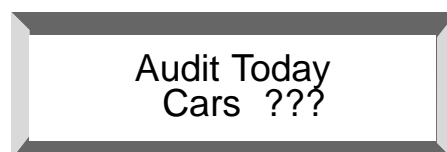

Section 1.9 continued ...

The screen then automatically scrolls up so the next is

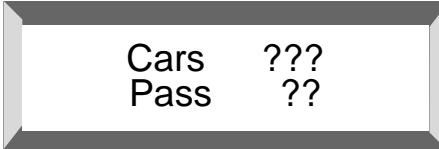

Cars ???
Pass ??

Press CANCEL to exit or wait 30 seconds and the screen steps back down the menu to the previous message, ie.

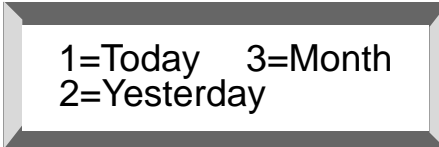

1=Today 3=Month
2=Yesterday

(In 30 seconds this screen steps down to the first menu screen)

Press 2

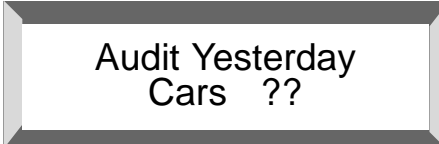

Audit Yesterday
Cars ??

Again this scrolls for **Cars** and **Pass**.

For the Month totals, from the Audit screen press 3

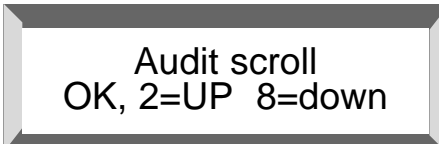

Audit scroll
OK, 2=UP 8=down

Press ENTER (for OK) for the current month, Audit is progressive, updated each 24 hours at midnight so a part days transaction is not included.

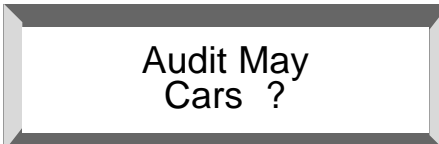

Audit May
Cars ?

The screen scrolls to then show **Pass** (all cards that are not public cars, ie. includes Discount cards etc). To select previous months press 2, then repeat up or down the months as required.

Section 1.9 continued ...

Personal Identification Number (P.I.N.)

This protects the **Setup** menu. There are three P.I.N.'s to protect various levels of setup. A common PIN for testing is 1234. No P.I.N. can be set in which case pressing ENTER accesses the menu. Setting the P.I.N.'s is done in the Setup menu.

Setup

From the first message screen Press ENTER.

Press 3 (setup)



Enter PIN and press ENTER

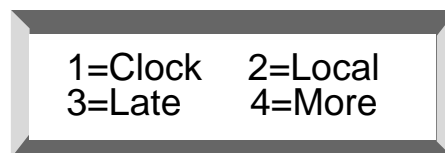

- 1 = Allows setting the clock.
- 2 = Sets the unique location of the Entrance or Exit stand within the car park, as each may have different operating parameters.
- 3 = Grace time to exit car park after payment.
- 4 = More menu.

Now access is available to various levels depending on the PIN.

Press 4 to step up the menu.

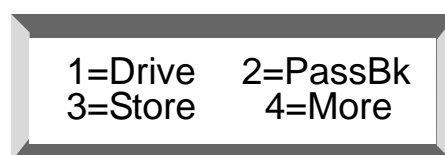

Section 1.9 continued ...

- 1 = The drive through time allowed.
- 2 = A time in which a Pass Card may not be reused, in the Entry or Exit (whichever was the last used) without having being used in the Exit or Entry (whichever was the next in sequence), ie. used in sequence and Pass Back time is irrelevant.
- 3 = If Pass card is expired on use then what is done with the card?
 CAPTURE & OPEN
 RETURN & OPEN
 CAPTURE it
 REJECT it
- 4 = More menu.

Press 4

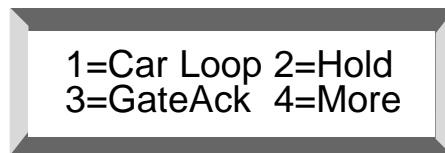

- 1 = Car present on loop yes or no. This refers to the use of a Pass card.
 Most systems set NO. Setting YES ensures fraudulent use of the Pass cards is at a minimum. Pass Cards are usually set up so once entered a car must leave before it can re-enter. This prevents a Pass card driver letting following drivers through the Entrance with his card. If the setting is NO the driver could still walk to the Exit, then use the card and return to let in another driver. If set YES the driver have to have a car at the Exit as well.
- Note: It is still possible to require a car to be on the loop when the button is pressed, for a normal parking card. This is done by wiring the button and loop in series (see wiring diagram).
- 2 = When issued to the driver the very end of the card is held in the magnetic card pinch roller to ensure it is not accidentally ejected from the stand, as may happen in windy conditions. More or less pinch is possible by setting a number in the **Hold** parameter, usually around 70 to 80.

Section 1.9 continued ...

3 = Is a "handshake" with the boom gate required?

If the boom gate is already operated when the next Pass or Exit card is inserted the pulse can be lost. The boom gate will close and lock the vehicle out, for an Entrance situation, or in if an Exit.

To prevent this occurring the boom gate should have a counter fitted and re-operate after each car. Alternatively the "Gate Acknowledgment" feature of the controllers can be used. This requires the boom gate to provide a pulse to the controller each time it operates. The controller in the Entrance or Exit stands will not output the next pulse until the boom gate issues a pulse.

4 = More menu.

Press 4

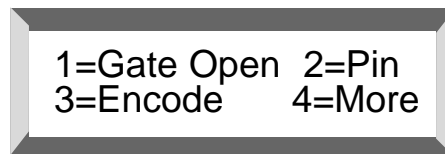

1 = Allows opening of the entry or exit boom gate at preset times (usually used to open the exit gate only during late night hours).

2 = Setting the user, Administration or Factory P.I.N.

3 = Sets up the Entrance or Exit machines to encode Pass cards. This feature cannot be accessed by the User P.I.N. There are several Pass card types that can be encoded. These include total access, access limited to a number of entries, access with an expiry day. Discount cards, Lost cards with penalty fees encoded etc. The parameters of the Pass card encodings is usually set up for each customer and only accessed via the Administration P.I.N.

4 = More menu

Section 1.9 continued ...

Press 4

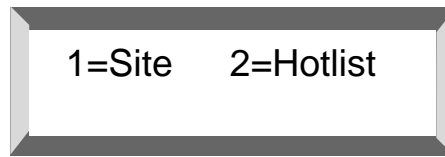

- 1 = The site number is encoded on all cards so access is restricted to this car park. This can only be set up on the insertion of the Factory P.I.N.
- 2 = P.I.N.s of Pass Cards to have entry or exit barred can be entered or removed. These numbers will be automatically sorted in sequential order. Up to 100 Pass cards can be Hot listed.

2.0

MANUAL PAY STATION DESKTOP CONTROLLER



Controller



Stalk Display



Rear View

Section 2.0 continued ...

Cash Drawer

When a customer Pay card is inserted, a fee is due and the ENTER key is pressed, then an output is given to a cash drawer. Likewise when a Pay or Refund is generated and the ENTER key is pressed the cash drawer signal is also given. This cash drawer is connected to a plug at the rear of the Desktop Controller.

Receipt Printer

This also plugs into the rear of the Desktop Controller.

Customer Display

Customer Display Messages

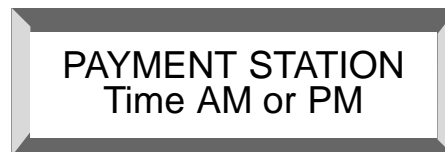

PAYMENT STATION
Time AM or PM

On inserting a public parking card the customer display shows

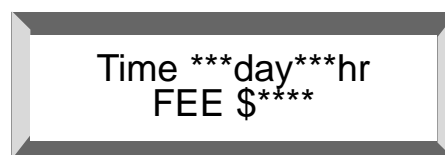

Time ***day***hr
FEE \$****

On payment the customer display shows

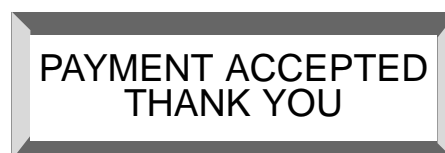

PAYMENT ACCEPTED
THANK YOU

If a Pass card is inserted the customer display shows the details, such as

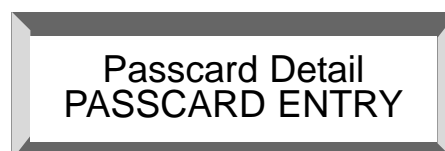

Passcard Detail
PASSCARD ENTRY

2.1 SETTING OF DESKTOP CONTROLLER

The desktop controller incorporates function keypads and numerical keypads to allow setting up and then operating of the car park system. An optional stalk display is available for customers' information. This stalk display plugs to the rear of the Desktop Controller.



Desktop Controller Keypad

PASS CARD	NOT USED	BOOM GATE	NOT USED
Manual Pay	Refund	Audit	Receipt

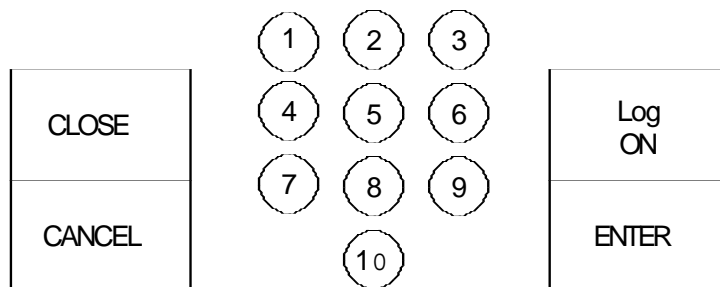

Keypad Layout

Section 2.1 continued ...

Access

This menu uses the numeric key pad plus the ENTER and CANCEL buttons to set up the operating system. To enter the set up menu press any **numbered** key.

The display shows

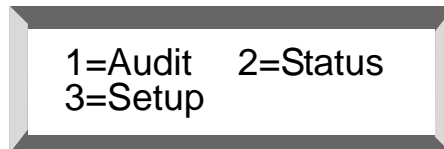

Only Audit and Status can be accessed if there is no Personal Identification Number (P.I.N.) entered.

There are three levels of P.I.N. User access, Administration access and Factory access. The User P.I.N. gains access to relatively unimportant menu items.

The Administration P.I.N. gains access to all operational menu items, including all those covered by the User P.I.N.

The Factory P.I.N. gains access to all menu items and is used to protect critical set-up parameters.

A User P.I.N. is not critical - it can be set to 0, but an Administration and a Factory P.I.N. must be used.

Set-Up

This section briefly shows the screen messages of the set-up menu and then each item is detailed more fully.

Press any number

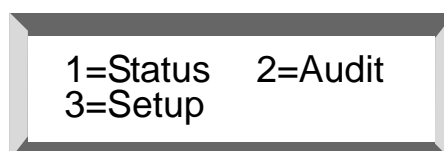

Section 2.1 continued ...

Press 3



Enter a P.I.N. and press ENTER.

(Assume a Factory PIN to allow access to all menu items).

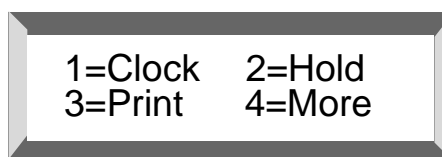

1 = Setting time and date.

2 = Setting the card dispensing parameters.

3 = Setting receipt printing parameters.

4 = More parameter settings.

Press 4

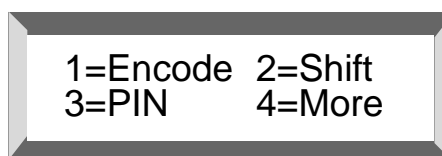

1 = Pass card Authorisation settings.

2 = Setting P.I.N. numbers for the shift operators (separate to the menu access P.I.N.'s, ie. User, Administration or Factory P.I.N.'s)

3 = Setting the User and Authorisation P.I.N. and if necessary the Factory P.I.N.

4 = More parameter settings.

Section 2.1 continued ...

Press 4

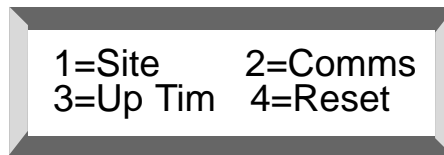

- 1 = Setting an identification number for the car park site.
- 2 = Setting an identification number for each Entrance and Exit. This allows different levels of access for Pass cards.
- 3 = Setting a communications address for each Entrance and Exit, used for electronic data transfer.
- 4 = Diagnostic reporting information.

Setting Menu Access Personal Identification Number (P.I.N.)

Press any key, press 3

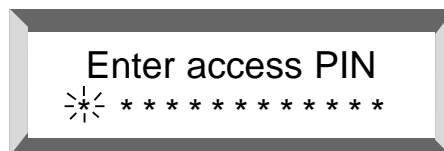

Changing the User (or Administration P.I.N.) can only be done if the Administration or Factory P.I.N. is entered. To change a P.I.N. the existing P.I.N. must be known - or the P.I.N. for a higher authority, ie. with only a User P.I.N. only that P.I.N. can be changed. With an Administration P.I.N. both Administration and User can be altered. With a Factory P.I.N. the User, Administration and Factory P.I.N. can be changed. When accessing a higher level the system displays lower level P.I.N.'s. Hence an Administrator can determine the User P.I.N. even if previously unaware of the number.

Press ENTER.

Section 2.1 continued ...

If an incorrect P.I.N. is entered the display shows



This display times out quickly to the previous screen. When the correct P.I.N. is keyed in press ENTER.

Key in the Administration P.I.N. and press ENTER.

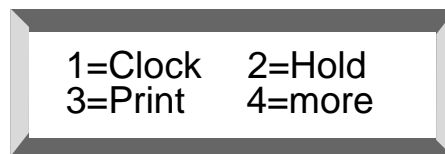

Press 4

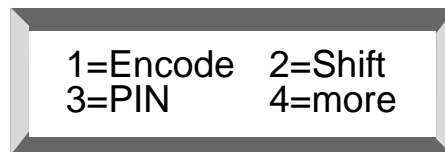

Press 3

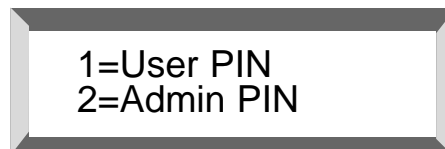

Changing the User P.I.N.

Select 1

Enter in a number between 2 and 12 digits and press ENTER.



Section 2.1 continued ...

Note: Set 0 and no P.I.N. is required to access the User menu.

Press ENTER

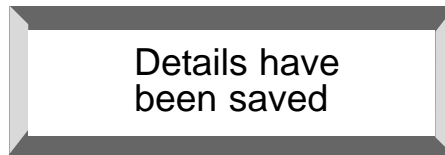

and the display quickly returns to

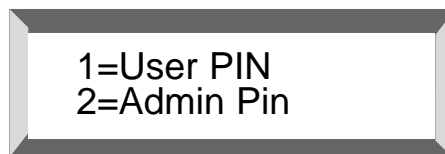

Changing the Administration P.I.N.

Select 2

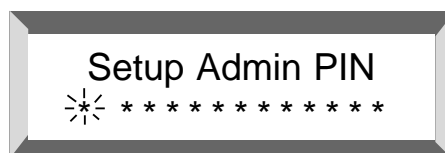

Enter a number of at least two digits and up to 12 digits.

Press ENTER

The screen steps back one level. Repeatedly press CANCEL to step back to the idle screen.

Section 2.1 continued ...

Setting the Clock

Press any number, Press 3. Enter User P.I.N. if set (or Administration P.I.N.).

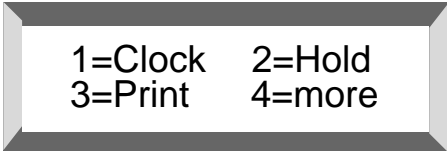

1=Clock 2=Hold
3=Print 4=more

Press 1

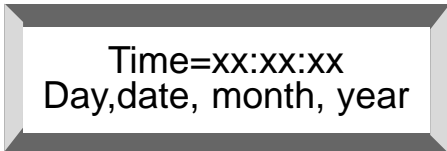

Time=xx:xx:xx
Day,date, month, year

A flashing number shows the one to be changed (or re-entered). As the date is altered the day (Sun - Mon etc) will automatically change. When the settings are correct press ENTER. To leave the clock screen press CANCEL.

If the communications between the desktop and the entrance and exit sites is operative, setting the desktop automatically sets the clocks in the Entrance and Exit units. If the communications is inoperative at any site that site will need to be manually set.

Installing Log On Shift P.I.N.

This can only be accessed via the Administration P.I.N.

The Shift Operator P.I.N.'s are not to be confused with the menu P.I.N.'s. The Operator P.I.N. allows the machine to be enabled and used, after logging on. The menu P.I.N.'s allow the Desktop Controller parameters to be set via the menu items.

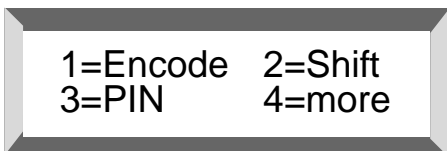

1=Encode 2=Shift
3=PIN 4=more

Section 2.1 continued ...

Press 2

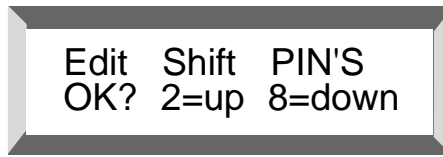

Press 2

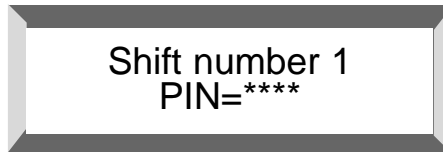

Enter new P.I.N. Press ENTER.

Note: Up to 8 shift P.I.N.'s can be used (Step up or down, press 2 or 8).

A shift P.I.N. can be one digit or up to eight digits. A single 0 (zero) is not acceptable as a Shift P.I.N.

The Shift P.I.N. number can be the same number as the User number, or it can be the same number as the Shift number, ie. Shift number 1 PIN=1.

Removing Log On Shift P.I.N.

Proceed as if setting up a PIN. Enter in a single 0. Press ENTER. This will remove the PIN altogether and access to the function keys will be denied, unless a new number is installed.

2.2

OPERATING DESKTOP CONTROLLER

Logging On

Set Shift. Idle screen shows



Log ON required
Time ****

Press LOG ON function key. Shift 1

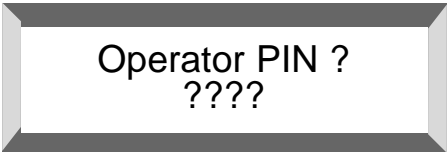

Operator PIN ?
????

Enter P.I.N.

Press ENTER



Start new shift
Enter=Log ON?

Press ENTER

Now the Function Keys are active.

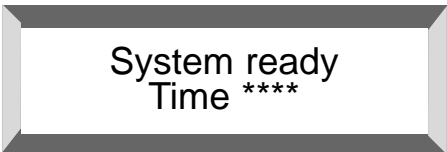

System ready
Time ****

Section 2.2 continued ...

Logging Off

Press LOG ON

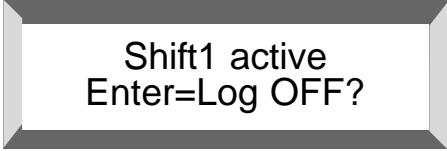

Shift1 active
Enter=Log OFF?

Press ENTER

Note: The receipt printer will then print a shift audit. If the printer is out of tickets or disconnected the display will indicate this but logging off will still occur.

Encoding Cards

Access to encoding of Pass cards can be allowed or denied the operator. This is set-up via the Administration P.I.N. If not authorised pressing the PASS CARD function key



Sorry Option is
not available

If authorised

First log ON.

Press the PASS CARD function key.



PASSCARD ENTRY

If this is the required card type press ENTER. If another type of card is required press the PASS CARD function key again and repeat the process until the card type is selected.

Section 2.2 continued ...

Options are set up for each customer. The "standard" list it: -

Public Entry	(Normal parking card after processing at the Entry)
Public Payment	(Normal parking card after processing at the Pay Station)
Master Passcard	(Access everywhere - may be limited to number of entries and an expiry date)
Exit Only Card	(Allows one exit only)
Fixed Pay Entry	(A fixed parking fee, payment needed before either entry or exit)
Fixed Payment	(A fixed parking fee, encoded on card and allows use of Entry before payment if required)
Discount Entry Discount Payment Discount Exit	(Allows parking on a fee structure set in the Pay Station or Desktop Controller - at a different rate to normal parking cards)
Passcard Entry	(Like a master card but exit and entrances must be used in sequence - at least during the Pass Back time set in Entry and Exit Controllers.
Passcard Exit	(As above but after processing by the Exit stand)

Then press ENTER.

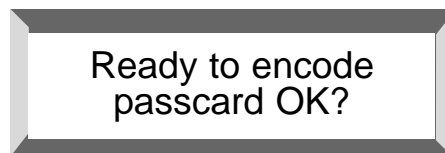

Press ENTER.

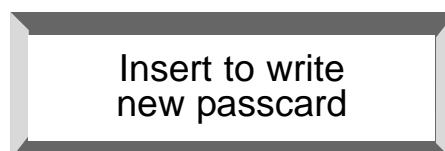

Section 2.2 continued ...

On inserting a card the screen shows

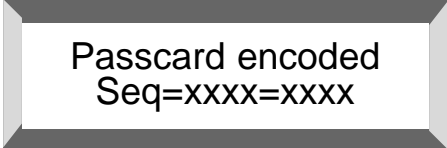

Passcard encoded
Seq=xxxx=xxxx

The card is removed and the controller is ready for another card. This will be encoded and will have the next sequential number. The first four digits are numbers based on the time and date and the last are sequentially numbered for that day of encoding. To exit this encoding programme press CANCEL to return to the idle screen.

Open Boom Gate

Press the BOOM GATE function key.



Control boomgate
Entry Gate One

To select other boom gates press BOOM GATE function key and repeat until the required gate is displayed. Press ENTER. The standard programme allows for 2 Entries and 2 Exits.

Press ENTER

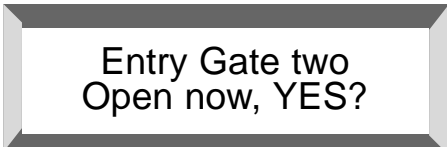

Entry Gate two
Open now, YES?

Press ENTER.

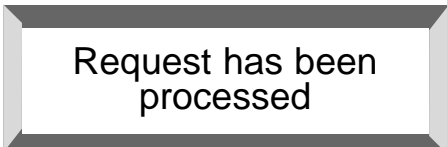

Request has been
processed

Section 2.2 continued ...

Press CANCEL to step back to the idle screen.

Note: If the communications with that gate are inoperative the display will show



Manual Payment

This allows payments to be made without having inserted a card to determine the amount due.

Press the MANUAL PAY function key.

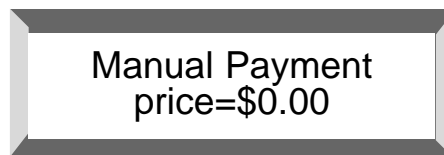

Enter in the amount of payment. If an error is made press CANCEL and start again. When the correct amount is shown press ENTER. The audit records will then be updated to show this transaction.

Refund

Similar to the Manual Payment, Refund allows the audit records to show repayments.

Press the REFUND function key.

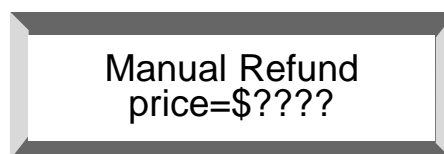

Enter the refund amount and press ENTER.

Section 2.2 continued ...

Audit

For currently active Shifts

This is for a display of the current shift totals.

Press the AUDIT function key

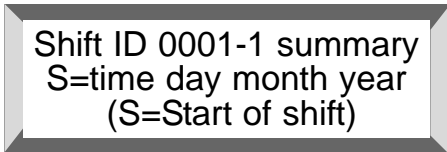

Shift ID 0001-1 summary
S=time day month year
(S=Start of shift)

The ID 0001 refers to a sequential shift numbering, ie, increments with each log on and off. The -1 refers to the operator on that shift.

This then toggles to also show

E=time of day month year (E=end of shift)
If still active display says "now active".
CASH=???
Manual \$???
Refund (-)???
Total ???

To obtain the current shift audit ticket press the AUDIT button again or ENTER.

Press CANCEL to return to the idle screen.

Detailed Audit

Provides historical audits of previous Shifts.

Press any of the number keys.

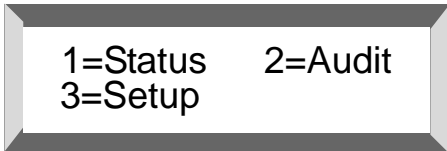

1=Status 2=Audit
3=Setup

Section 2.2 continued ...

Press 2



Enter Menu Access P.I.N. (note this is different access to the Shift log on and off access - but it can be set up to use the same numbers.

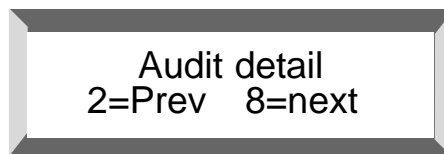

The screen flips to show

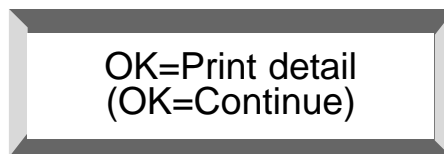

Press ENTER.

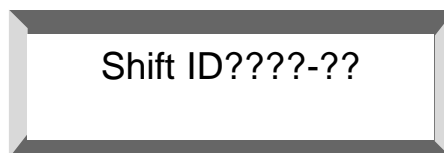

Details of the current or last Shift are shown, as shown under Shift audit previously detailed.

To print an audit ticket press ENTER.

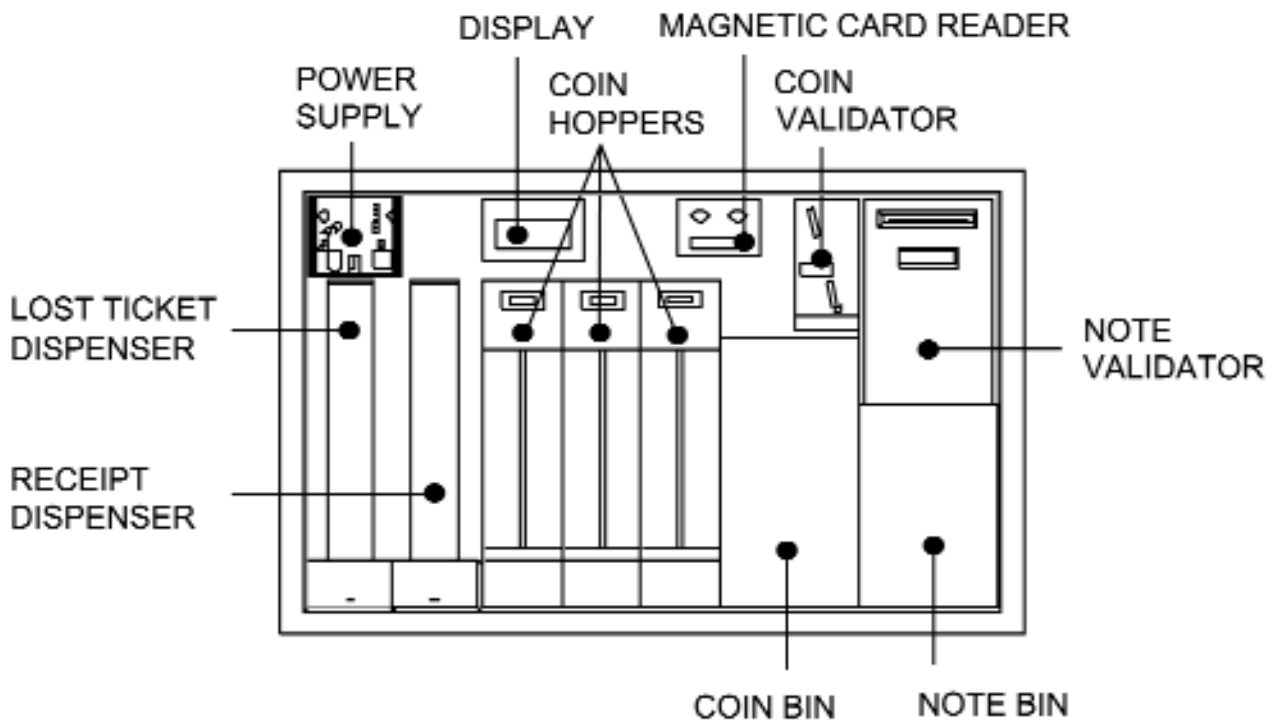
3.0**PAY STATION****APS 2500P INTERIOR - version 1**
Standard Component Layout**MODULE PORTS**
(5 IN TOTAL)*Typical Pay Station*

There are a range of Pay Stations with varying features. The following information is of a general nature to be applied where relevant.

3.1

CASH COLLECTION PROCEDURES

There are a number of possibilities, but in general there are the low security and the high security methods. Both require entering a P.I.N. (Personal Identification Number), stored in the electronic cash box lid. Abberfield Technology can set up various P.I.N.'s to suit different customers and a factory default is 1234. Later equipment may also have included PIN 1357.

Low Security Cash Collection Method

Allows extraction of cash at the machine site.

- The P.I.N. can be entered on the coin box via three buttons.

Note 1: The audit resets on removal of the cash box. To protect against not receiving an audit ticket (out of tickets etc), a non resetting audit ticket can be taken first. Press the two outside buttons of the cash box lid momentarily and an audit ticket will be issued. If not issued reload tickets or fix the dispenser/printer problem. Issuing of this audit ticket does not reset the audit counters.

Removing of the cash box will reset the audit counters.

Note 2: Operating as above, if the printer is inoperative the display will ask for a PIN. This is the change clock PIN, NOT the remove cash box PIN.

- First press the centre button (ENTER). The display will then show P.I.N.
- Then toggle the left button until the first digit on the coin validator display shows the correct number.
- Follow this with the right button for the second digit.
- Repeat with the left button for third digit and the right button again for the fourth digit.
- The press ENTER button (centre).
- If there is a ticket dispenser /printer as part of the hardware an audit ticket will be printed.

Cash Collection Procedures continued...

- The display will show GOOD and after a moment the cash box will unlock from the machine. When fully unlocked the power supply will beep.
- The cash box can then be removed. **DO NOT ATTEMPT TO REMOVE THE CASH BOX UNTIL IT IS FULLY UNLOCKED.**
- When the coin bin is removed the electronic cash box lid will slide off and access to the coins can be gained.
- The note bin can then be removed and emptied, after unlocking the top hinged lid.
- The coin dispenser can be unplugged and the top lid removed. At this time further coins can be added, taking care not to add foreign matter (string off money bags etc.).
- When the coin dispensers are re-inserted make sure that they go back into the correct positions. These should be marked on the moulding around each plug.
- Then insert the note bin, followed by the coin bin.
- **MAKE SURE THE COIN BIN IS PUSHED IN FULLY, PUSH AT THE TOP SO THE ELECTRONIC LID WILL ENGAGE CORRECTLY.**
- The cash box will then self check and if all is correct it will then lock itself into position.

High Security Cash Collection Method

This entails exchange of the cash modules at the machine and remote processing of these modules.

- Open the machine door and lower the coin dispenser ram (described above).
- Enter the cash box P.I.N. and remove the coin and note bin.
Note: In the high security mode, although the coin bin unlocks from the machine, the electronic coin bin still cannot be removed.
- Insert a new, empty note bin and coin bin, plus re-stocked coin dispensers.
- The cash modules are then processed in a secure area and access to the coins is only obtained after the electronic lid has been connected to a computer carrying a cash processing programme. This procedure transfers the data from the machines to the computer for Management Information purposes.

3.2

RESETTING CLOCK

To reset the machine time, first press both of the outside coin box lid buttons together. If there is a ticket printer hold the buttons down until the ticket has been dispensed and printed. Only after completion release the buttons. Without a printer the buttons may be released promptly.

The display then says P.I.N.

This PIN is the first digits of Abberfield Technology's phone number (9939).

To enter toggle the left button until the flashing display says 9.

Toggle the right button until the next flashing display says 9.

Repeat for the next two digits to show 3 and the 9 and press ENTER.

The time will then be shown on the display but will flash on and off to signify it is in the programme mode.

The left or right buttons can be toggled to advance or retard the clock.

When set press the ENTER (centre) button.

3.3

FAULT INSPECTION

On opening the cabinet door a row of lights will be seen on the power supply, with the names of the modules against each light. A green light indicates operative condition, red indicates a fault and orange suggests attention is needed. Examples of orange could be:-

Receipt Dispenser = Out of tickets.

Coin Dispenser = Out of change.

Note Validator = Jammed note.

Should there be a fault (red against a module) and the fault is not obvious then turn the power off, wait a few seconds and turn the power on again. This will reset the software and may clear the problem.

Error Codes

In addition to the status indicating lights there are error codes that display on the 4 digit LED and coin validator display. This coded message provides much greater detail as to the fault condition.

*Fault Inspection continued...***ABBERFIELD TECHNOLOGY****REVENUE COLLECTION****MACHINE SELF DIAGNOSIS OPERATION TESTING**

The lights on the power supply will indicate the condition of components in the machine.

Operative = green
 Disabled = orange
 Faulty = red

Orange often indicates operational errors such as:-

- * Ticket dispensers out of tickets.
- * Coin hoppers out of coins.
- * Cash box full.

COIN VALIDATOR ERROR CODES

The coin validator is prone to vandalism or misuse and in normal operation considerable dirt accumulates within the coin guide. Therefore there are service codes to indicate if any optical sensors are inoperative.

- Err 0 Coin validator system fault.
- Err 1 Wake up optic (first optic).
- Err 2 Diameter optic (second optic).
- Err 3 Diameter optic (third optic).
- Err 4 Coin to bin optic.

Service is usually limited to cleaning the coin track and optic devices, plus the coin to bin reflective prism.

MACHINE ERROR CODES

When a new cash box is inserted into a machine, it performs a series of tests on the machine. If there is something wrong with the machine, one of the following error codes will be displayed on the coin validator when the machine door is opened. Please note that not all error codes are applicable to all machines.

Machine Control

- E - 01 = Shutdown request, power turned off.
- E - 02 = Configuration data has changed. Turn power off - wait 10 seconds and then turn on again.
- E - 03 = Machine location details invalid.
- E - 04 = Machine type not known by cash box.

Cash box Problems

- E - 10 = Cash box is too old. Process the cash box.
- E - 11 = Cash box from other machine. Process the cash box.
- E - 12 = Audit log copy routine problem.
- E - 13 = Cash box lock routine problem.
- E - 14 = Cash box button pressed or stuck.
- E - 15 = Price table setup problem.
- E - 16 = Maximum coin level exceeded.



A B B E R F I E L D
 T E C H N O L O G Y

32 Cross Street, Brookvale 2100, Sydney, Australia
 Tel: (02) 9939 2844 Fax: (02) 9938 3462
 International Tel: +61 2 9939 2844
 Email: contact@abberfield.com.au
 24 hour service mobile: 0414 427 708

Machine Hardware Problems

- E - 20 = Machine clock reset failed.
- E - 21 = Power supply control mode failed.
- E - 22 = Machine config table problem.
- E - 23 = Audit data problem.
- E - 24 = Device 1 problem.
- E - 25 = Device 2 problem.
- E - 26 = Device 3 problem.
- E - 27 = Device 4 problem.
- E - 28 = Spare.
- E - 29 = Spare.
- E - 30 = Coin validator problem.
- E - 31 = Note validator problem.
- E - 32 = Mag card reader problem.
- E - 33 = Door button problem.
- E - 34 = Coin dispenser 1 problem.
- E - 35 = Coin dispenser 2 problem.
- E - 36 = Coin dispenser 3 problem.
- E - 37 = Coin dispenser 4 problem.
- E - 38 = Ticket dispenser 1 problem.
- E - 39 = Ticket dispenser 2 problem.
- E - 40 = Ticket dispenser 3 problem.
- E - 41 = Ticket dispenser 4 problem.

Fault Inspection continued...

System Reset

If ever a machine behaves in a manner that is considered not normal, it is recommended that the power supply is turned off and after shutting down, restarted. Turning off the power must be carried out with the door open. If turned off with the door shut the machine will then operate on its internal batteries.

Disconnecting power provides a system, reset and on start up instigates an even more intensive diagnostic evaluation of the equipment.

System Update

The technology used in the Abberfield equipment is generally “State of the Art” and the boundaries of current knowledge and practice are constantly tested. Benefits flow from the provision of more simple but functionally better systems and the company uses this technology to provide commercial advantages to our customer partners. Evidence is the ever decreasing size and cost of the Abberfield Technology systems whilst at the same time the increase in system capability.

Since the modules used are easily replaced, the latest technology can be readily implemented. This upgrade service is available as a right of ownership of any Abberfield equipment.

Technical Support

Abberfield Technology remain available to answer any queries or provide any technical support. If needed please contact our sales support or technical support team.

4.0

SERVICE

Full details are provided in the Workshop Manual, issued on application only. The essential issue for any car park operation is to assume responsibility for cleaning the equipment. Particularly the magnetic ticket reading heads but also removal of dust and dirt from the system. In the same way cleaning of recycled plastic parking tickets is necessary.

Cleaning Magnetic Heads

Special cleaning cards can be purchased from Abberfield Technology. These are credit card size lint type material soaked in alcohol and sealed in a satchel. To use, remove the cleaning card from the satchel and insert it into the card reader, where it will run backwards and forwards before being rejected. In the process dirt accumulated on the head and rollers will be transferred to the card. Whilst the card is still wet it can be used in another machine, providing dirt accumulation still allows effective cleaning. Frequency of cleaning depends on the car park usage and site conditions. For busy sites, particularly where dust and dirt is wind blown into the system, daily cleaning is recommended.

This cleaning process is very effective and takes only a moment. It is recommended that the cleaning takes place at the same time as tickets are being removed from the exit or being restocked into the entrance.

*Cleaning card satchel
and instructions*

DOUBLE-SIDED CLEANING CARD FOR MAGNETIC CARD READERS

CONTAINS 99.9% isopropyl alcohol

Cleaning cards eliminate read errors by safely and effectively removing contamination from magnetic stripe card readers. Recommended for all Abberfield magnetic card systems.

USAGE

Once per week for low use readers. Twice per week for high usage readers. Once per day in high contamination environments.

DIRECTIONS

Remove card from pouch.

Insert card into reader.

Remove card from reader and dispose of properly.

Caution: Flammable

Made in U.S.A. especially for



32 Cross St, Brookvale,
Sydney 2100 Australia
Tel: +61 (0)2 9939 2844
Fax: +61 (0)2 9938 3462

Service continued...

Cleaning Head Box

The magnetic reading head is lightly sprung loaded so as to follow the slightest deflection in the card as it travels through the reader.

Over time dust and dirt may accumulate down the sides of the head and impede the free travel of this sprung loaded magnetic reading head. This will result in retries for encoding or even “unreadable card” being displayed by the system. Dependant upon use, each three months the top of the head and head guide should be cleaned with a stiff brush (toothbrush) and isopropyl alcohol or methylated spirits.

To obtain access to the flight deck and magnetic heads remove the two larger screws (M4) on top of the head box and unplug. Re-plug with care and do not over tighten the holding screws. During this cleaning process the power ought to be disconnected.

Dust Removal

It is recommended that dust is removed from the system with a soft brush. This reduces the chance of dust accumulating on the ticket dispenser and magnetic card reader optic sensors. Most at risk are these under the ticket stack (sold out detectors) and just in front of the ticket dispenser front roller (dispense confirmation detectors). Sold out sensors reflect invisible light up from the dispenser, off the ticket and back to the dispenser. Dust falling down the sensing holes can cover the optic detectors. Likewise the ticket dispensed optics look from the dispenser, off of a reflector and back to the dispenser. The underside of the reflector can be cleaned with a soft cloth and the holes for the optics cleaned with a very small soft brush. An effective alternative is to blow in the general direction of the sensors.

Cleaning Parking Tickets

Plastic parking tickets reused many times becomes the least expensive means of control, (paper tickets are once use only). To achieve this economy and reliable performance from the system, it is necessary that tickets that are recycled back into the entry unit are free of dirt or water. The dirt will contaminate the magnetic reading heads and the water will cause the tickets to stick together.

Service continued...

Clearance of Exit Stands

Cards from an Exit Stand should be collected and returned to an office environment for checking and cleaning. **They should not be taken directly from the Exit and placed in the Entry Stand.**

Cleaning and Checking Cards

Each card should be wiped and visually inspected for damage, particularly the magnetic stripe, plus the leading and trailing edge. **The cards must be totally free of water before restocking.** In very dry weather, plastic cards build up a static charge and this can be avoided by occasionally wiping with an anti-static cloth. This should only be needed each month, or even three months, depending on whether there is evidence of static. Do not use in wet weather.

When using an anti-static cloth some solvent will be left as a film on the card. It is critically important to lay the cards out individually on a towel to dry thoroughly. It is desirable to turn the cards over to ensure both sides are thoroughly dry. If the cards are stacked with solvent still wet they will jam in the entry ticket dispenser.

Reloading of Entry Stands

Only use clean and totally dry cards that have had occasional wiping with an anti-static cloth. **Never load wet cards.**

Anti Static Wet Wipes

Abberfield supply wet wipes in a sealed container. Open the snap lid and pull out a cloth. Hold the second cloth and pull apart the perforation. Ensure the lid is kept closed to avoid drying out of the cleaning solvent.

Caution

Do not store wet wipes in direct sunlight or hot areas. Keep out of reach of children.

Receipt Ticket Storage

The paper tickets used for receipt tickets should be stored in a cool dry area. This avoids curling of the ticket stock.

Receipt tickets should not be stored bound by an elastic band, as this can cause distortion to the ticket edges which may result in ticket feeding problems.

4.1

MAINTENANCE & WORKSHOP SERVICE

There is further maintenance that ought to be carried out to the equipment, detailed in the Abberfield Service and Maintenance Manual considered outside the scope of an Operational Manual. The operator of the equipment needs to be satisfied that the periodical maintenance is being carried out.

Amendment Notes

The following amendment note pages are included so that operators may record any matter relevant to the car parking system and keep this together in one document.

Amendment Notes

The following amendment note pages are included so that operators may record any matter relevant to the car parking system and keep this together in one document.